

Ocean Modeling I

Ocean Modeling Basics and CESM Ocean Model

Susan Bates

Climate Change Research Section
Climate and Global Dynamics Laboratory
National Center for Atmospheric Research



Topics

- Challenges for ocean modeling
 - Ocean properties
 - CESM ocean model
 - Governing equations
 - Ocean model grid
 - Advection schemes
 - Boundary conditions
 - New to CESM2
-
- Parameterizations => Peter Gent's talk; but will cover the overflow parameterization and the new Estuary Box Model

Ocean Modeling Challenges

Irregular Domain

Physical Map of the World, April 2004

- AUSTRALIA Independent state
- Bermuda Dependency or area of special sovereignty
- Sicily / AZORES Island / island group
- ★ Capital

Scale 1:33,000,000
Robinson Projection
standard parallels 36°N and 36°S



April 2004

Source: U.S. National Oceanic and Atmospheric Administration
Map data: U.S. National Oceanic and Atmospheric Administration
Map design: National Geographic Society
Map production: National Geographic Society

ANTARCTIC PHOTOGRAPHY UNIT

Ocean Modeling Challenges

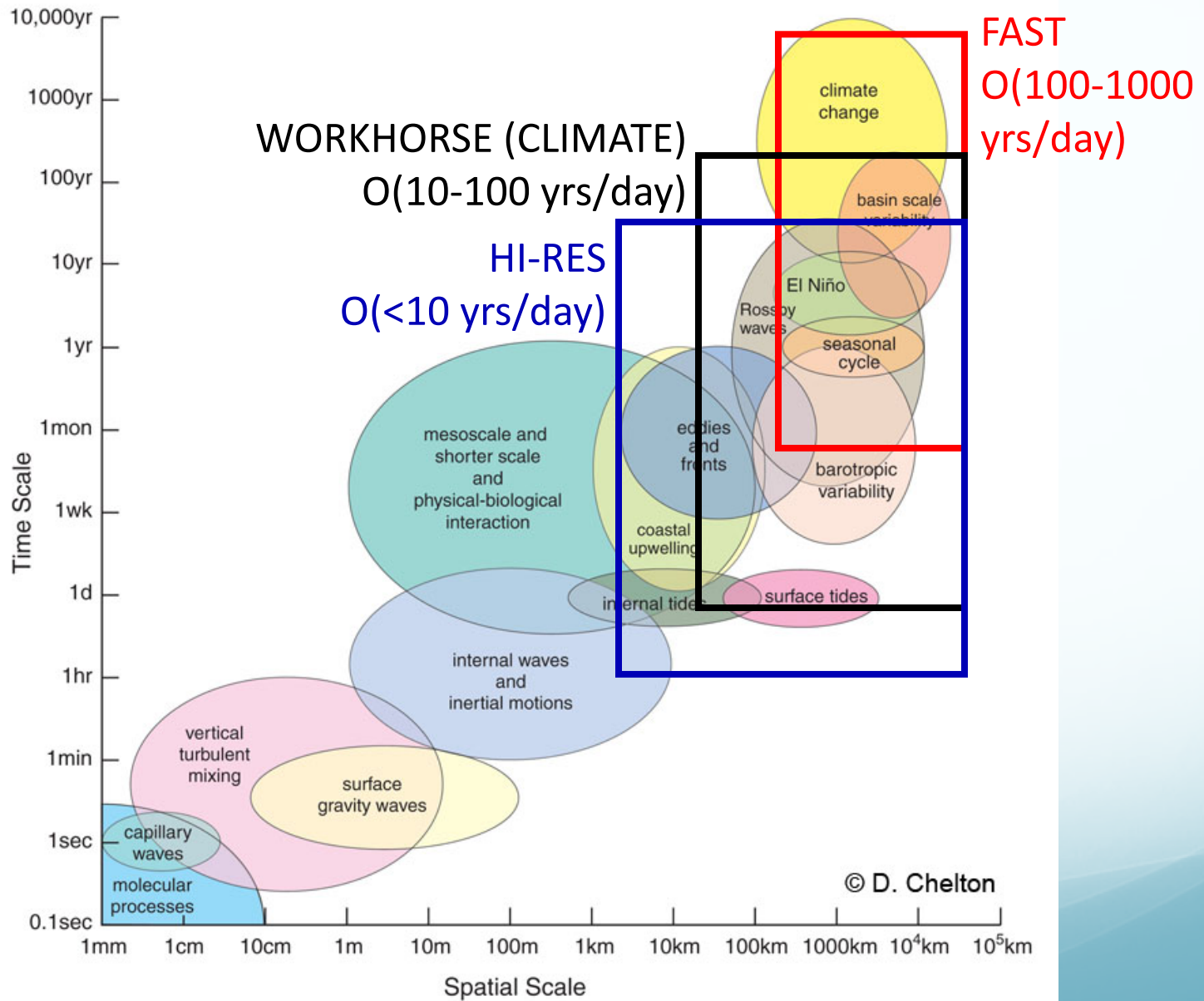

Ocean Modeling Challenges

Spatial Scales of Flow

Snapshot of Sea Surface Height

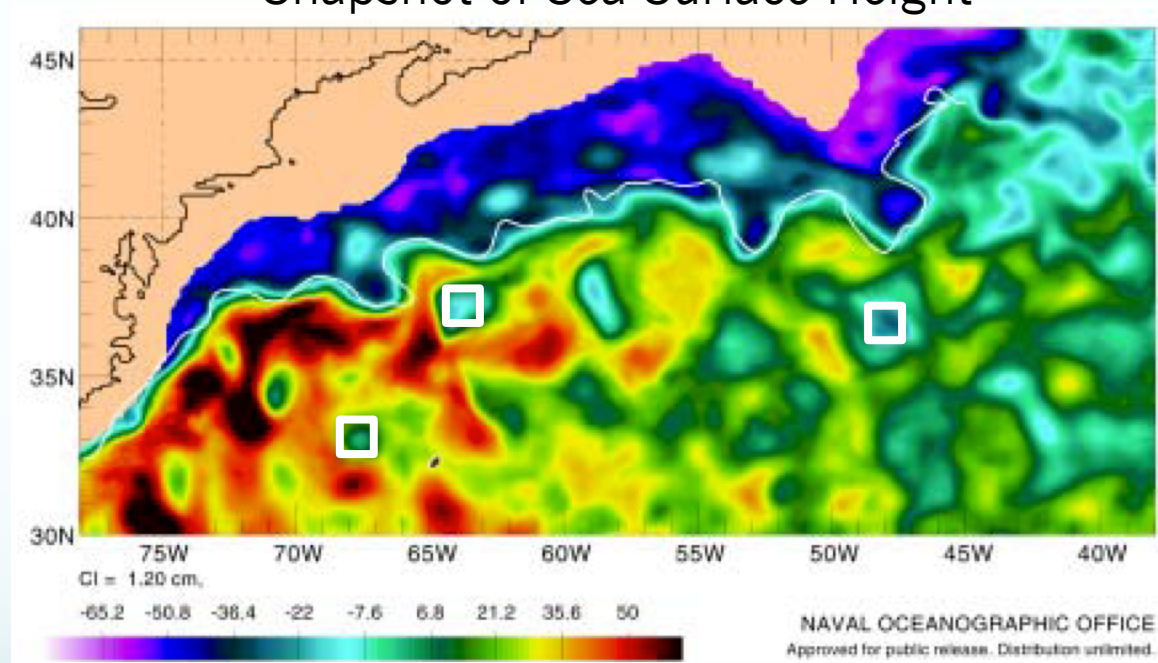

Ocean Modeling Challenges

Eddy-Resolving Scales

R. Hallberg/*Ocean Modelling* 72 (2013) 92–103

93

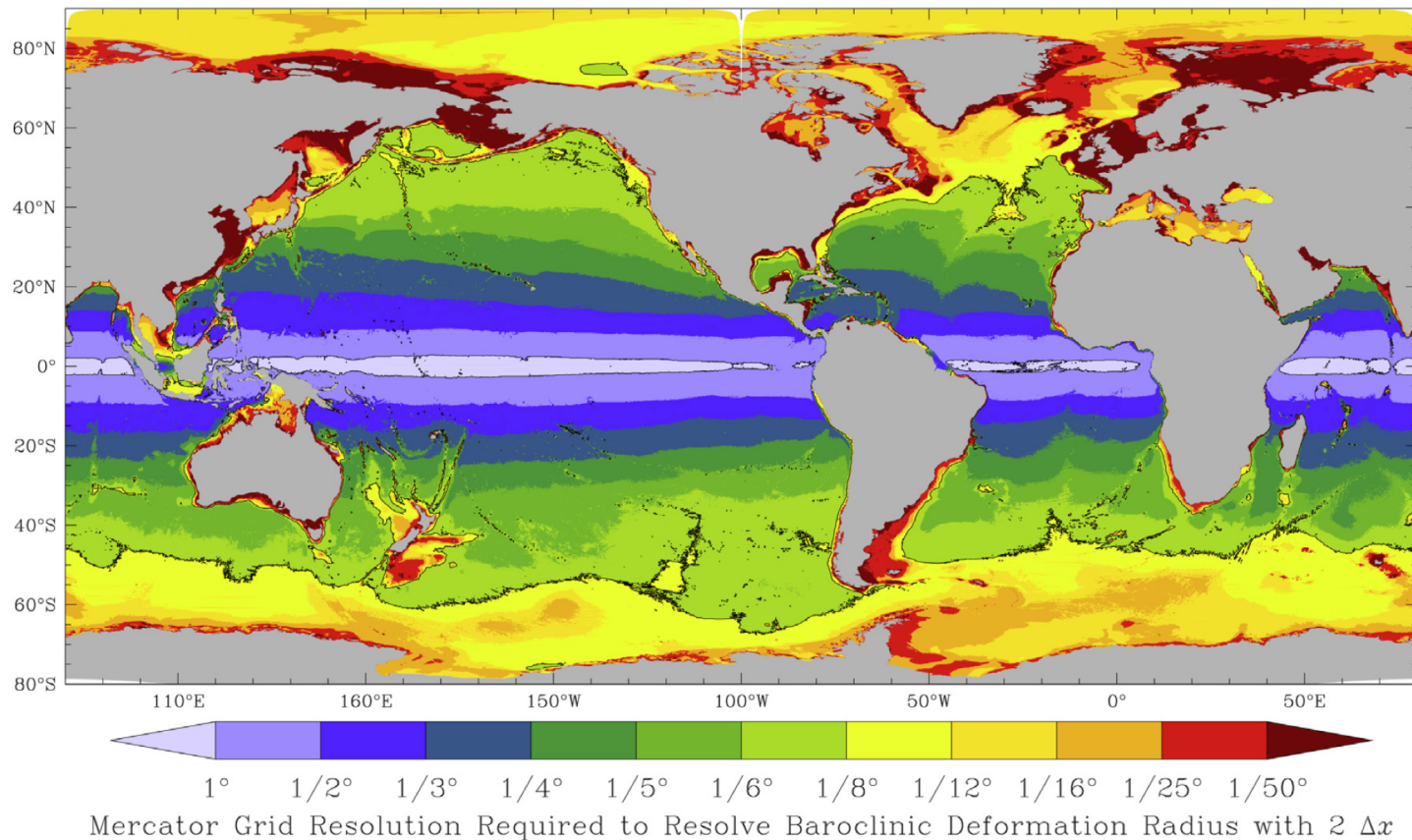

Fig. 1. The horizontal resolution needed to resolve the first baroclinic deformation radius with two grid points, based on a $1/8^\circ$ model on a Mercator grid (Adcroft et al., 2010) on Jan. 1 after one year of spinup from climatology. (In the deep ocean the seasonal cycle of the deformation radius is weak, but it can be strong on continental shelves.) This model uses a bipolar Arctic cap north of 65°N . The solid line shows the contour where the deformation radius is resolved with two grid points at 1° and $1/8^\circ$ resolutions.

Ocean Modeling Challenges

Equilibration Timescale

Scaling argument for deep adjustment time:

$$\begin{aligned} H^2/\kappa &= (4000 \text{ m})^2 / (2 \times 10^{-5} \text{ m}^2/\text{s}) \\ &= 0 (>20,000 \text{ years}) \end{aligned}$$

Bottom Line for Climate

- Performing long (climate scale) simulations at eddy-resolving / permitting resolution are not practical
- Must live with deep ocean not being at equilibrium in most simulations

Some Ocean Properties

- The density change from top to bottom is much smaller than the atmosphere. This makes the Rossby radius much smaller – 100s to 10s km.
- There is extremely small mixing across density surfaces once water masses are buried below the mixed layer base. This is why water masses can be named and followed around the ocean.
- The ocean is a 2 part density fluid (temperature and salinity).

Some Ocean Properties

- Top to bottom “lateral” boundaries.
- The heat capacity of the ocean is much larger than the atmosphere. This makes it an important heat reservoir.
- The ocean contains the memory of the climate system... Important implications for decadal prediction studies.



CESM Ocean Model

Parallel Ocean Program version 2 (POP2)

- POP2 is a level- (z-) coordinate model developed at the Los Alamos National Laboratory (Smith et al. 2010).
- 3-D primitive equations in general orthogonal coordinates in the horizontal are solved with the hydrostatic and Boussinesq approximations.
- A linearized, implicit free-surface formulation is used for the barotropic equation for surface pressure (surface height).
- The global integral of the ocean volume remains constant because the freshwater fluxes are treated as virtual salt fluxes, using a constant reference salinity.

Model Equations

7 equations in 7 unknowns:

3 velocity components

potential temperature

salinity

density

pressure

Plus: 1 equation for each passive tracer, e.g. CFCs, Ideal Age.

Model Equations

Momentum equations:

$$\frac{\partial}{\partial t}u + \mathcal{L}(u) - (uv \tan \phi)/a - fv = -\frac{1}{\rho_0 a \cos \phi} \frac{\partial p}{\partial \lambda} + \mathcal{F}_{Hx}(u, v) + \mathcal{F}_V(u) \quad (2.1)$$

$$\frac{\partial}{\partial t}v + \mathcal{L}(v) + (u^2 \tan \phi)/a + fu = -\frac{1}{\rho_0 a} \frac{\partial p}{\partial \phi} + \mathcal{F}_{Hy}(u, v) + \mathcal{F}_V(v) \quad (2.2)$$

$$\mathcal{L}(\alpha) = \frac{1}{a \cos \phi} \left[\frac{\partial}{\partial \lambda}(u\alpha) + \frac{\partial}{\partial \phi}(\cos \phi v\alpha) \right] + \frac{\partial}{\partial z}(w\alpha) \quad (2.3)$$

$$\mathcal{F}_{Hx}(u, v) = A_M \left\{ \nabla^2 u + u(1 - \tan^2 \phi)/a^2 - \frac{2 \sin \phi}{a^2 \cos^2 \phi} \frac{\partial v}{\partial \lambda} \right\} \quad (2.4)$$

$$\mathcal{F}_{Hy}(u, v) = A_M \left\{ \nabla^2 v + v(1 - \tan^2 \phi)/a^2 + \frac{2 \sin \phi}{a^2 \cos^2 \phi} \frac{\partial u}{\partial \lambda} \right\} \quad (2.5)$$

$$\nabla^2 \alpha = \frac{1}{a^2 \cos^2 \phi} \frac{\partial^2 \alpha}{\partial \lambda^2} + \frac{1}{a^2 \cos \phi} \frac{\partial}{\partial \phi} \left(\cos \phi \frac{\partial \alpha}{\partial \phi} \right) \quad (2.6)$$

$$\mathcal{F}_V(\alpha) = \frac{\partial}{\partial z} \mu \frac{\partial}{\partial z} \alpha \quad (2.7)$$

Model Equations

Continuity equation:

$$\mathcal{L}(1) = 0 \quad (2.8)$$

Hydrostatic equation:

$$\frac{\partial p}{\partial z} = -\rho g \quad (2.9)$$

Equation of state:

$$\rho = \rho(\Theta, S, p) \rightarrow \rho(\Theta, S, z) \quad (2.10)$$

Tracer transport:

$$\frac{\partial}{\partial t}\varphi + \mathcal{L}(\varphi) = \mathcal{D}_H(\varphi) + \mathcal{D}_V(\varphi) \quad (2.11)$$

$$\mathcal{D}_H(\varphi) = A_H \nabla^2 \varphi \quad (2.12)$$

$$\mathcal{D}_V(\varphi) = \frac{\partial}{\partial z} \kappa \frac{\partial}{\partial z} \varphi, \quad (2.13)$$

Model Equations

- Continuity: can't deform seawater, so what flows into a control volume must flow out.
- Hydrostatic: when ocean becomes statically unstable ($\rho_z > 0$) \Rightarrow vertical overturning should occur, but cannot because vertical tendency has been excluded. This mixing is accomplished (i.e., parameterized) by a very large coefficient of vertical diffusion.

Model Grid

displaced pole

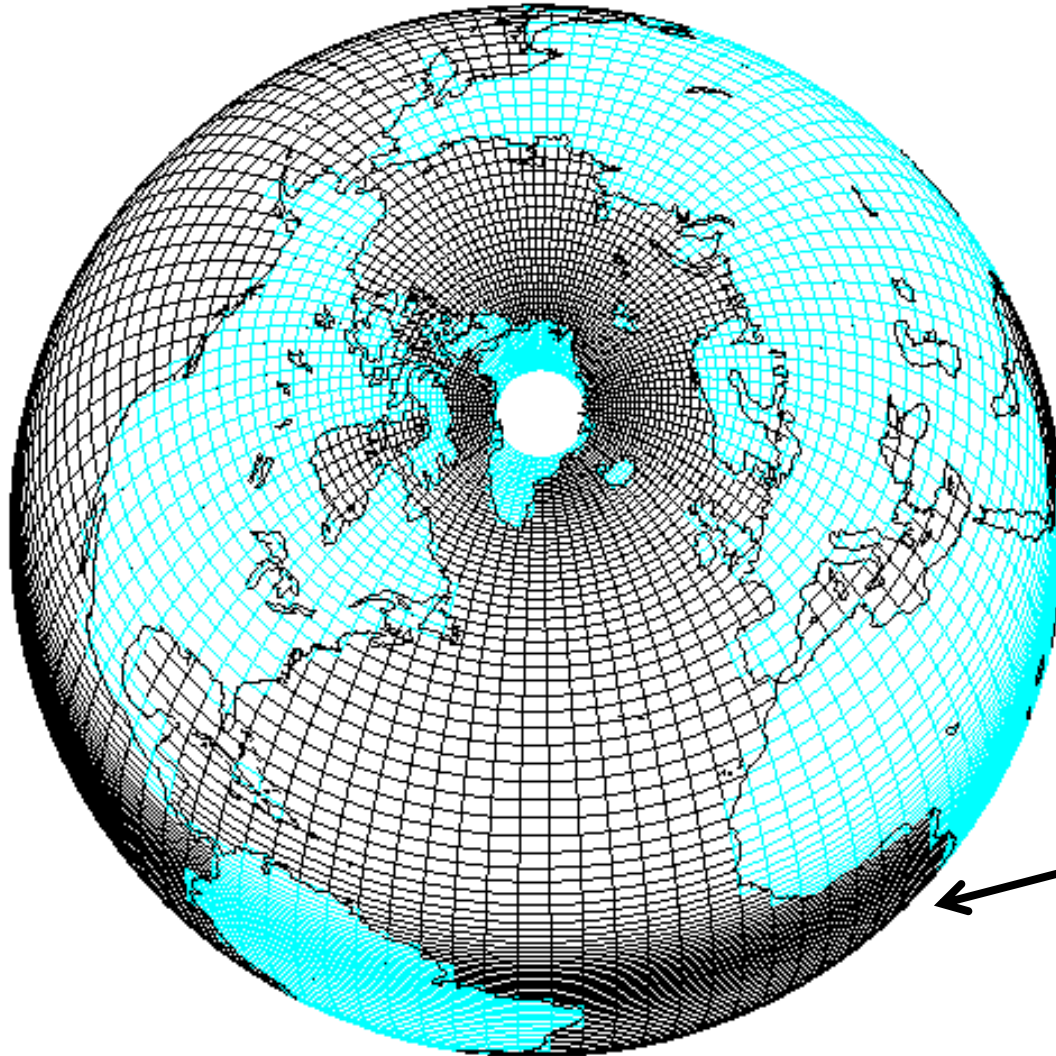

gx1: climate workhorse
nominal 1°

gx3: testing
nominal 3°

Ex. f19_g37
gx3v7

Equatorial refinement
($0.3^\circ / 0.9^\circ$)

Model Grid

tripole



tx0.1

Finite Differencing Grid

B-grid

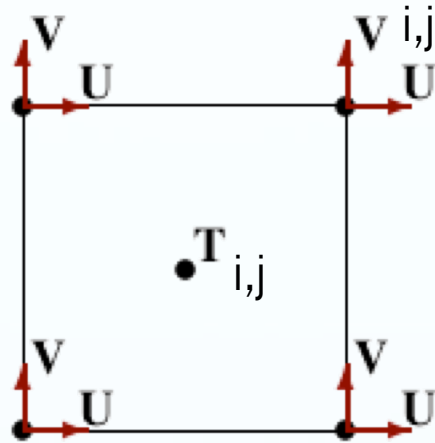

Top view

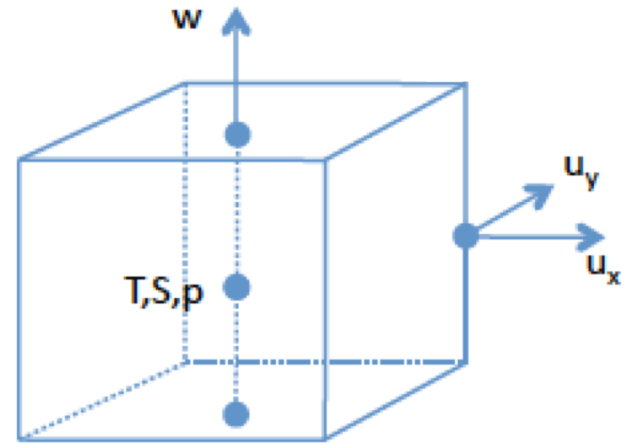

Model Grid

B-grid

T=tracer grid, U=velocity grid

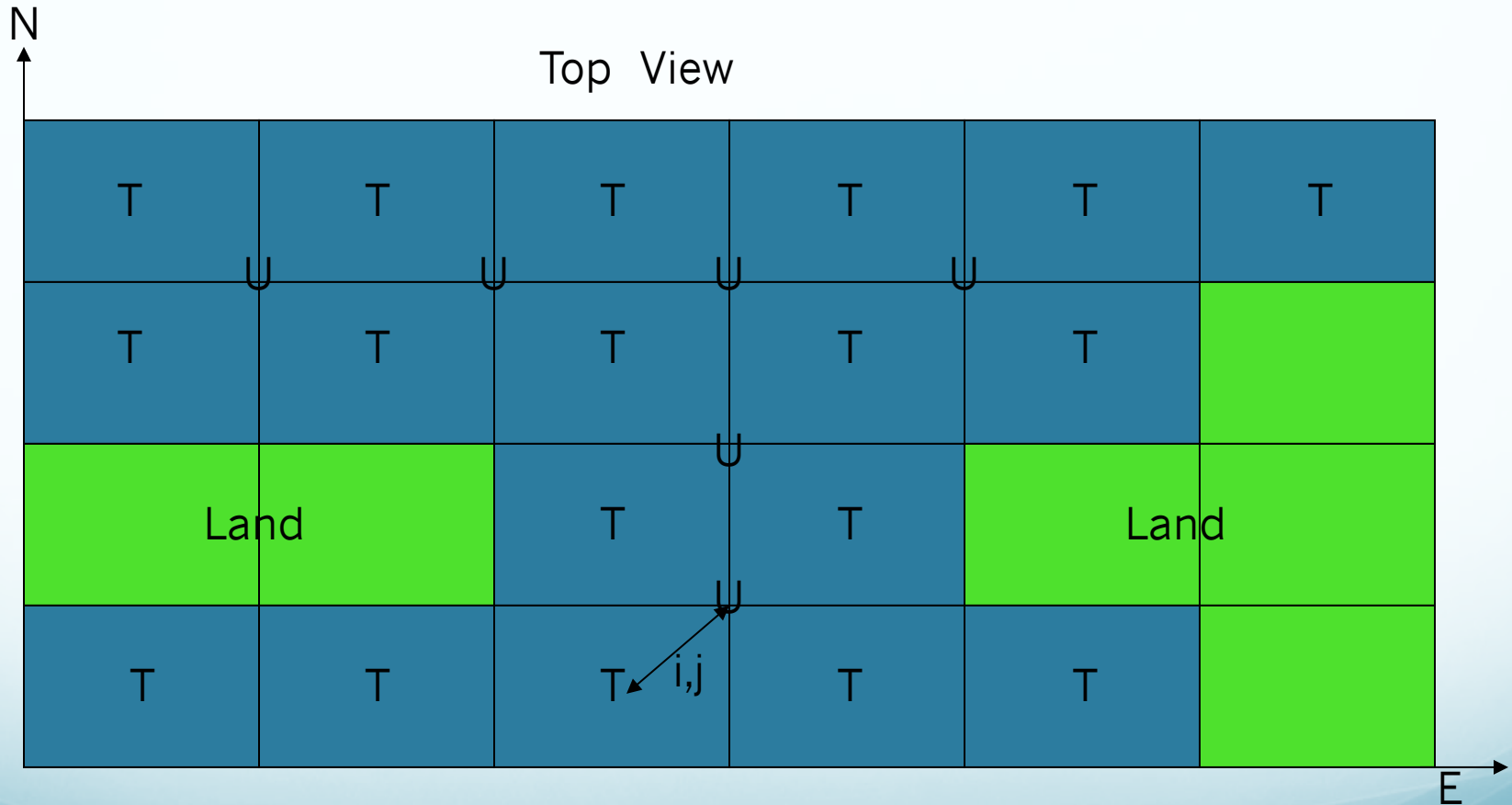

Model Grid

B-grid

T=tracer grid, U=velocity grid

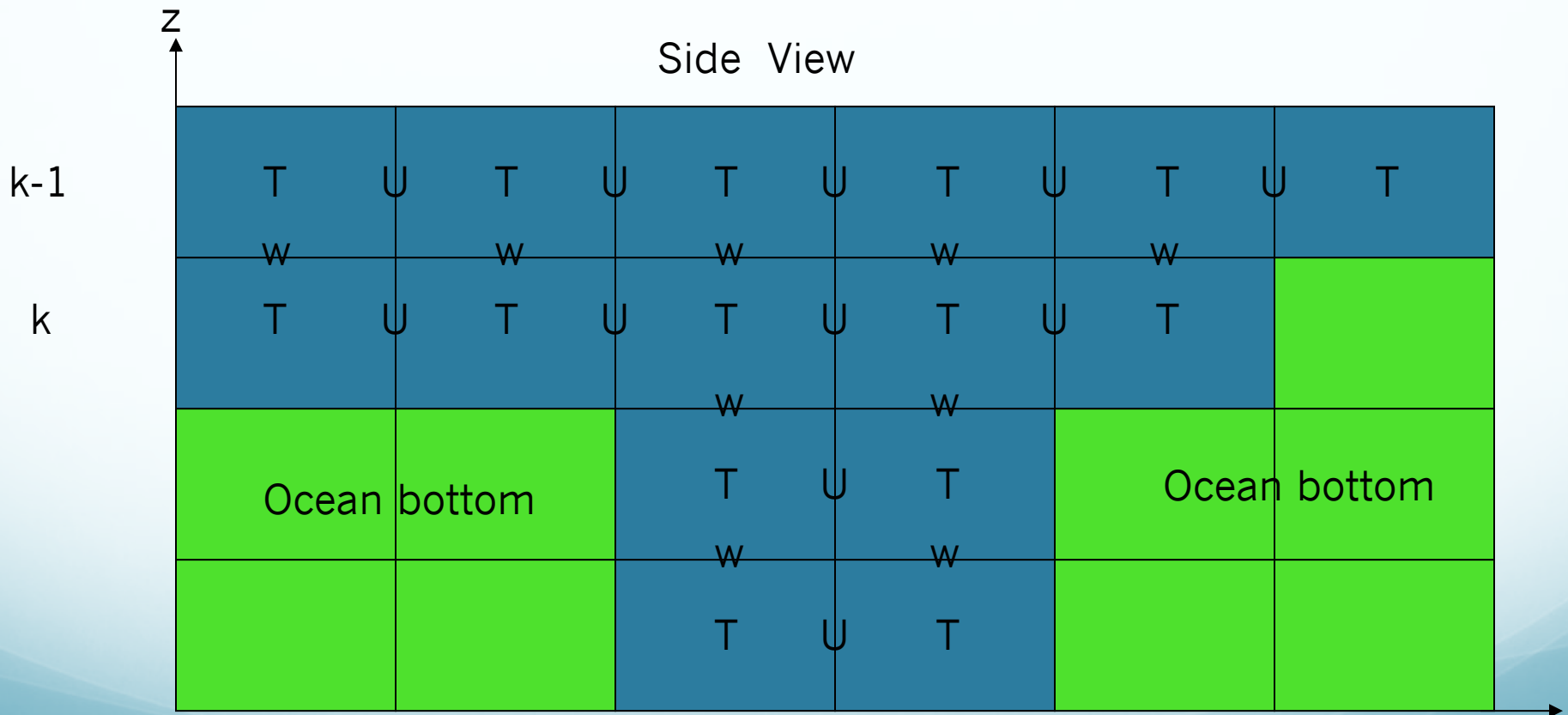

Model Vertical Grid

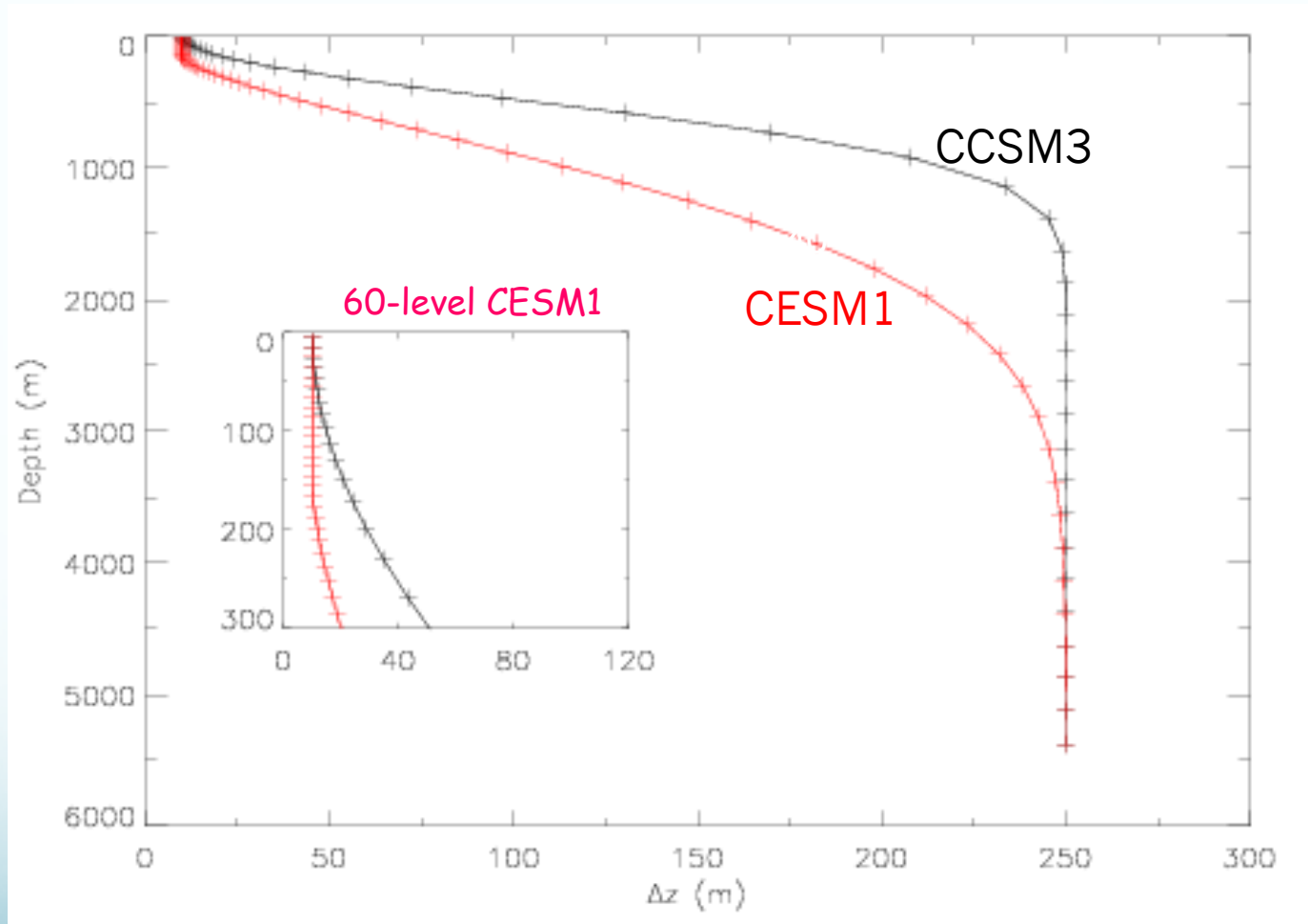

Advection

Current practice:

- Momentum: centered differencing (2nd order)
- Tracers: upwind3 scheme (3rd order)
 - Concerned with keeping within physical limits

Baroclinic & Barotropic Flow

- Issue: Courant-Friedrichs-Lewy (CFL) stability condition associated with fast surface gravity waves.
 - $u(\Delta t/\Delta x) \leq 1$
 - Barotropic mode $\sqrt{gH} \sim 200$ m/s
- Split flow into depth averaged barotropic ($\langle U \rangle$) plus vertically varying baroclinic (U')
$$U = \langle U \rangle + U'$$
- Implicit, linearized free-surface formulation obtained by combining the vertically integrated momentum and continuity equations
 - changes in surface height = flow divergence

Boundary Conditions

- Free surface
 - Flux exchanges at surface: momentum and tracers
 - because we conserve volume, if one place comes up another must come down
- Ocean bottom
 - No tracer fluxes (but option of geothermal heating)
 - Normal velocity is zero
- Lateral boundaries
 - No tracer fluxes
 - Flow normal to solid boundary is zero
 - No slip

Surface Forcing Options

- Fully coupled mode (B compset)
- Forced ocean (C compset) or ocean – sea-ice coupled (G compset)

Coordinated Ocean-ice Reference Experiments (CORE)

- Inter-annual forcing (IAF; 1948-2009)
<http://data1.gfdl.noaa.gov/nomads/forms/mom4/CORE.html>
- Normal Year Forcing (NYF): good for model testing and parameterization impact studies

Large and Yeager, NCAR Technical Note (2004)

Large and Yeager, *Climate Dynamics* (2009)

Danabasoglu et al., *Ocean Modelling* (2016)

- Future: JRA-gogo

Air-Sea Coupling

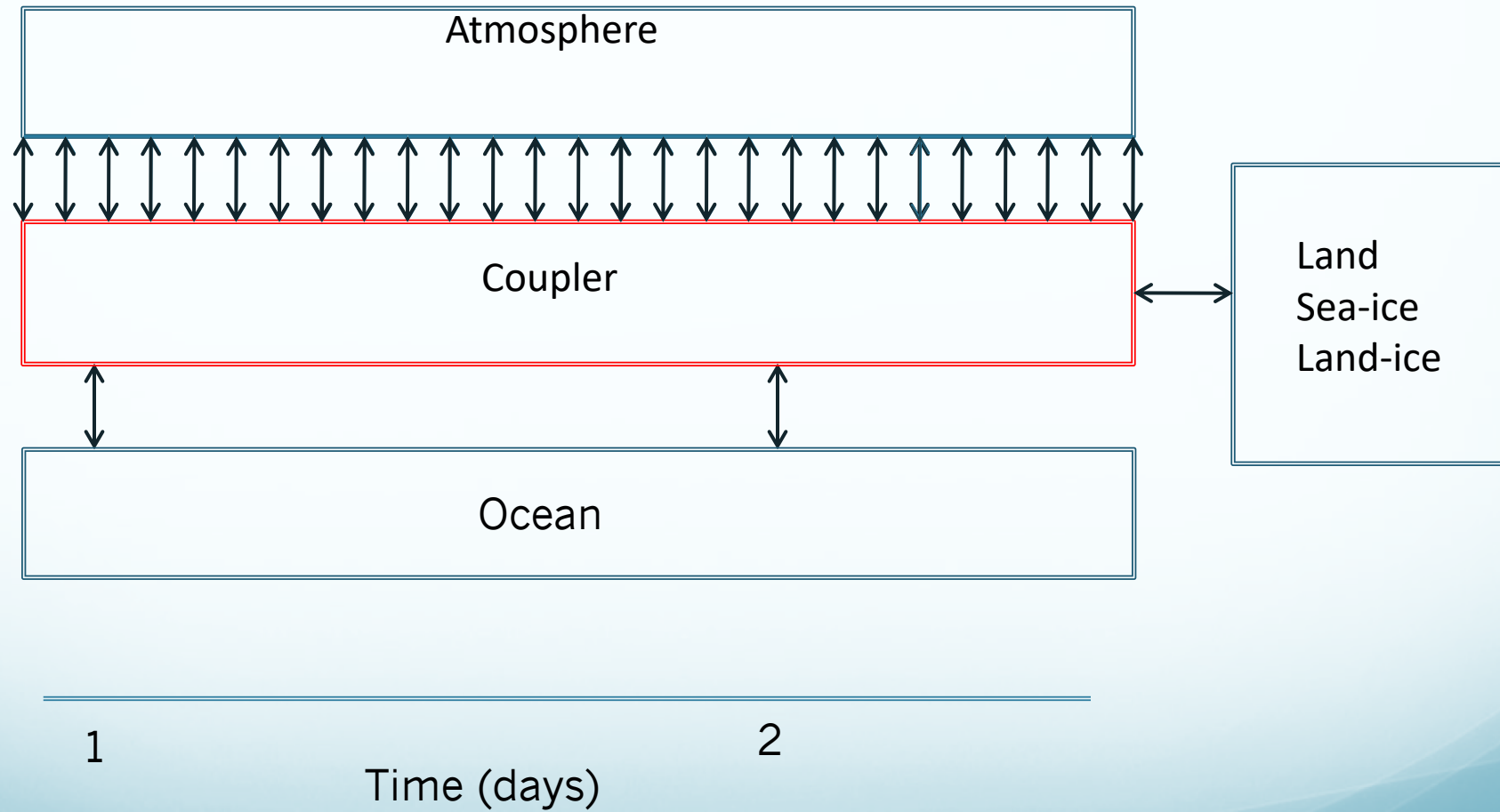

GRAVITY CURRENT OVERFLOWS

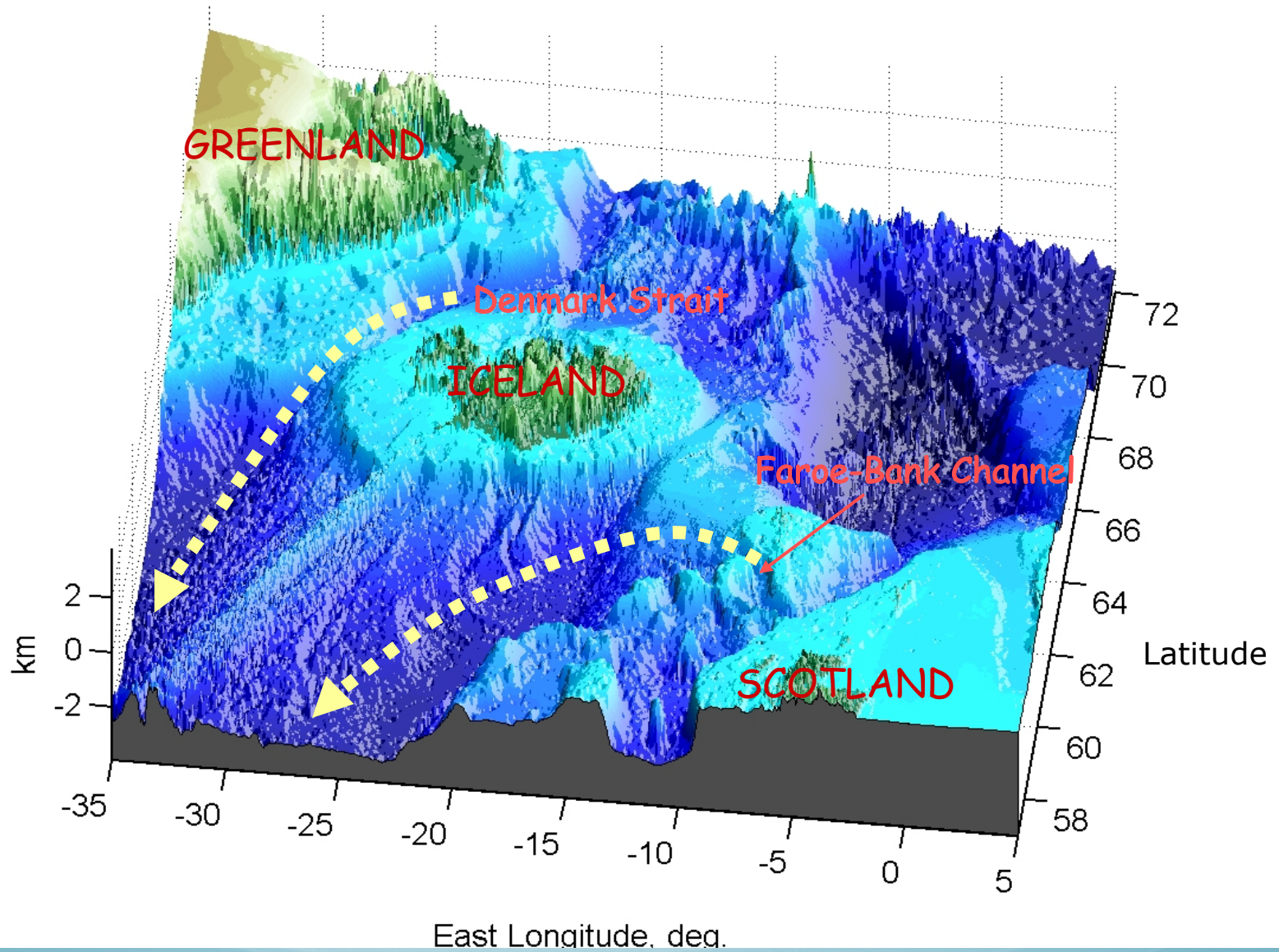

Model Grid

B-grid

T=tracer grid, U=velocity grid

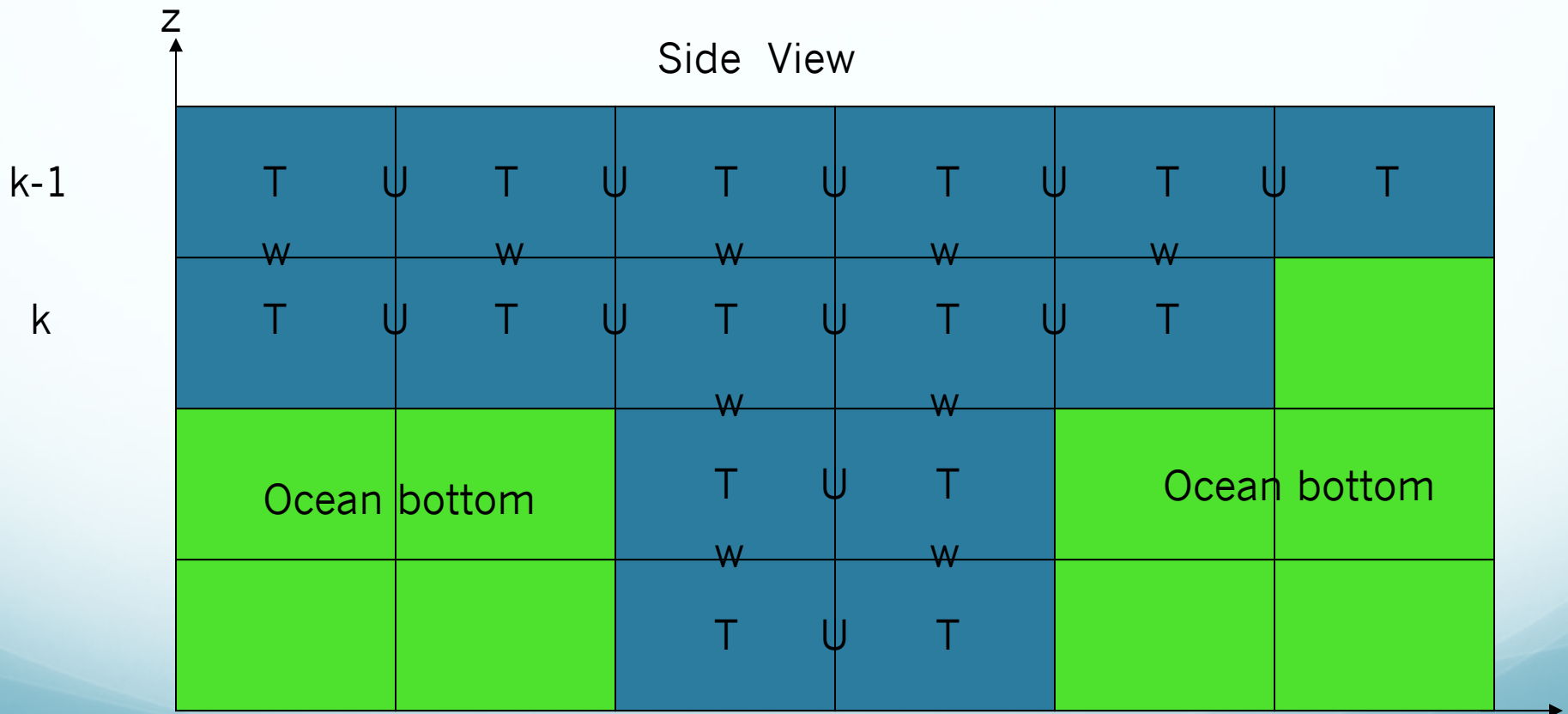

OVERFLOW PARAMETERIZATION SCHEMATIC

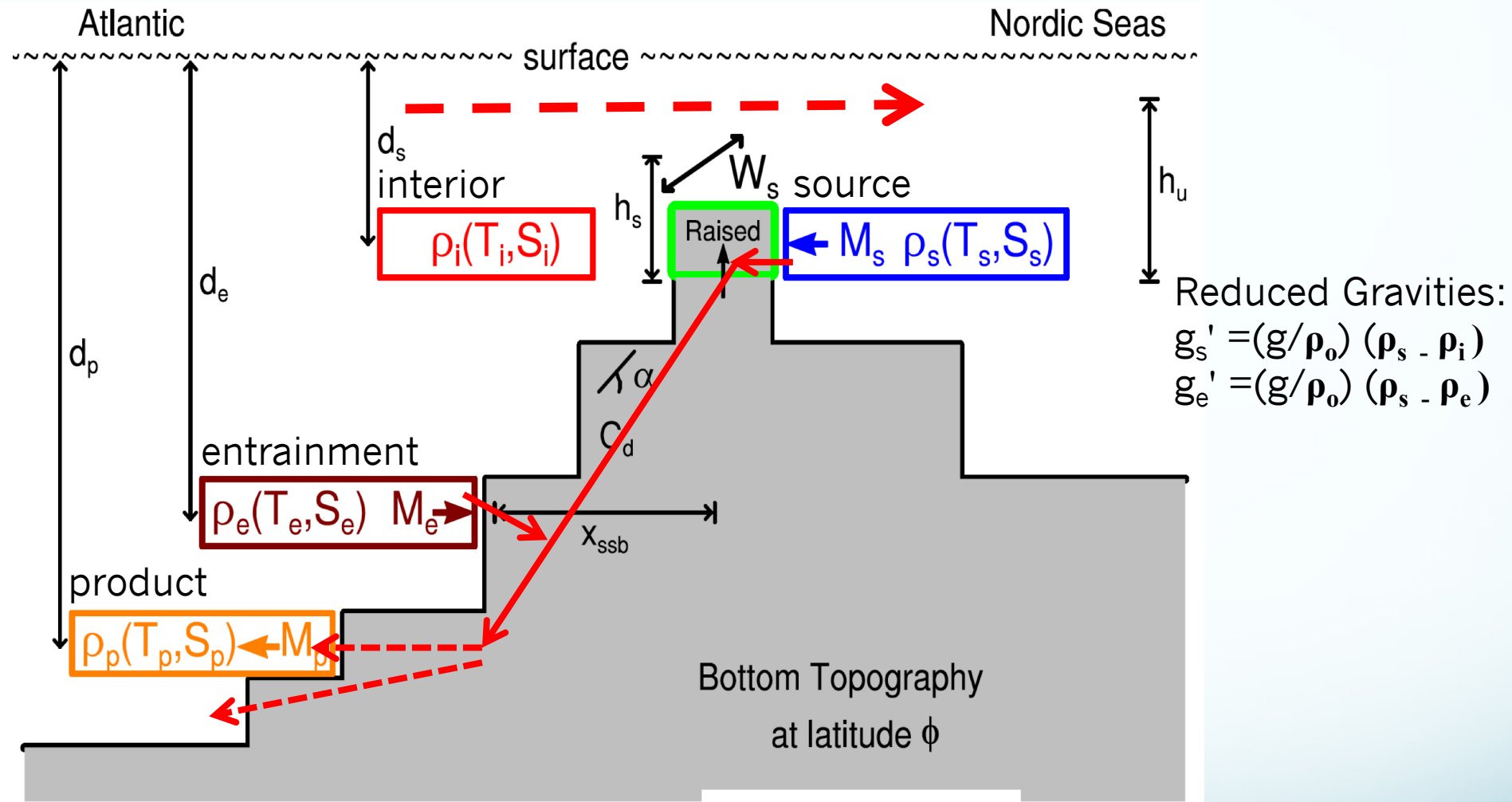

$$M_s = \frac{g'_s h_u^2}{2f}$$

$$M_p = M_s + M_e,$$

$$T_p = T_s(1 - \vartheta) + T_e \vartheta,$$

$$S_p = S_s(1 - \vartheta) + S_e \vartheta$$

$$M_e = M_s \left(\left\{ g'_e \mathcal{F}(\alpha, f, C_d, M_s, W_{ssb}) \right\}^{2/3} - 1 \right)$$

$$\vartheta = \frac{M_e}{M_s + M_e} = \frac{M_e}{M_p}.$$

BOTTOM TOPOGRAPHY OF THE x1 RESOLUTION OCEAN MODEL

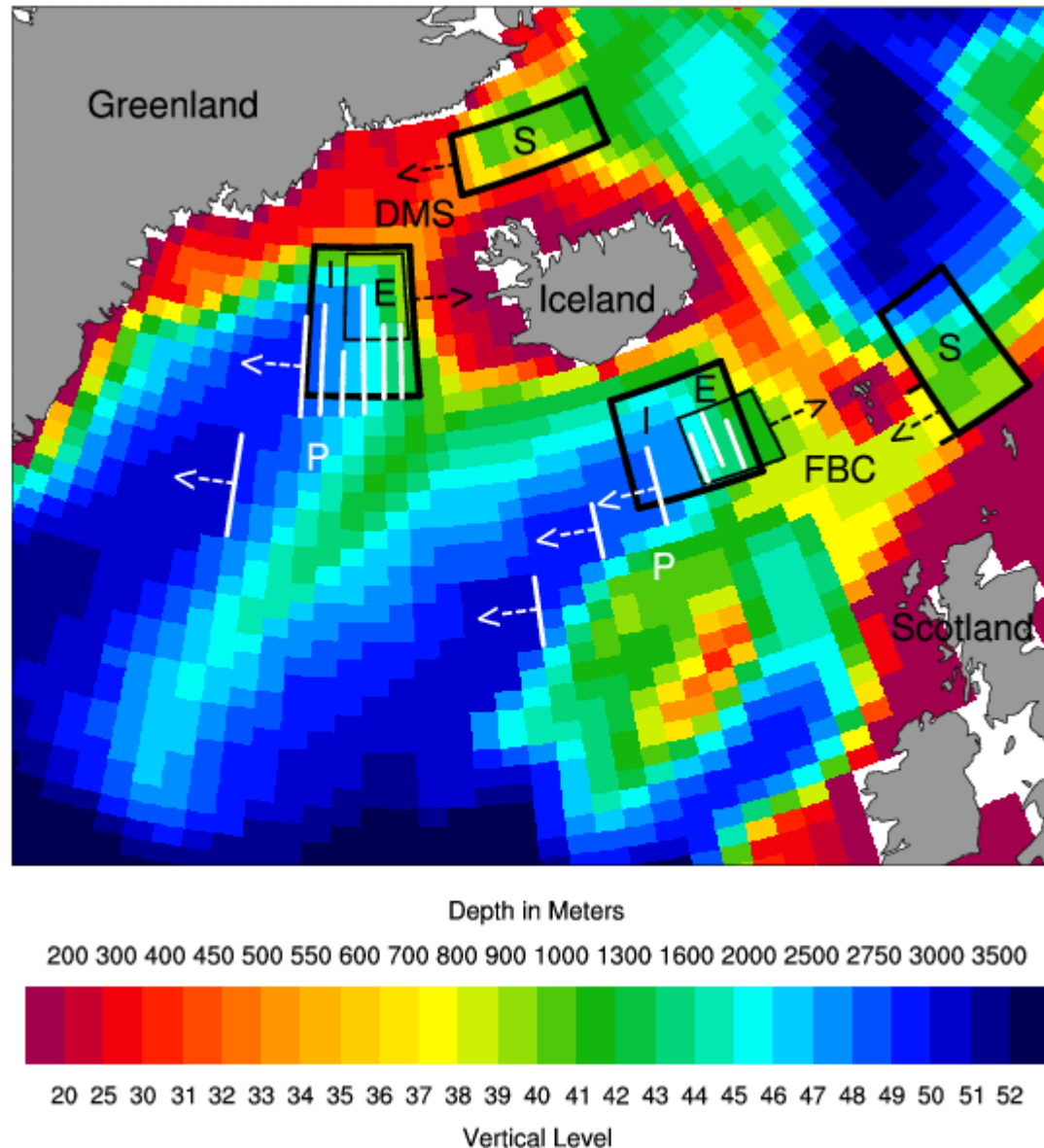

Based on Price & Yang (1998); described in Briegleb et al. (2010, NCAR Tech. Note) and Danabasoglu et al. (2010, JGR)

ATLANTIC MERIDIONAL OVERTURNING CIRCULATION (AMOC)

OCN

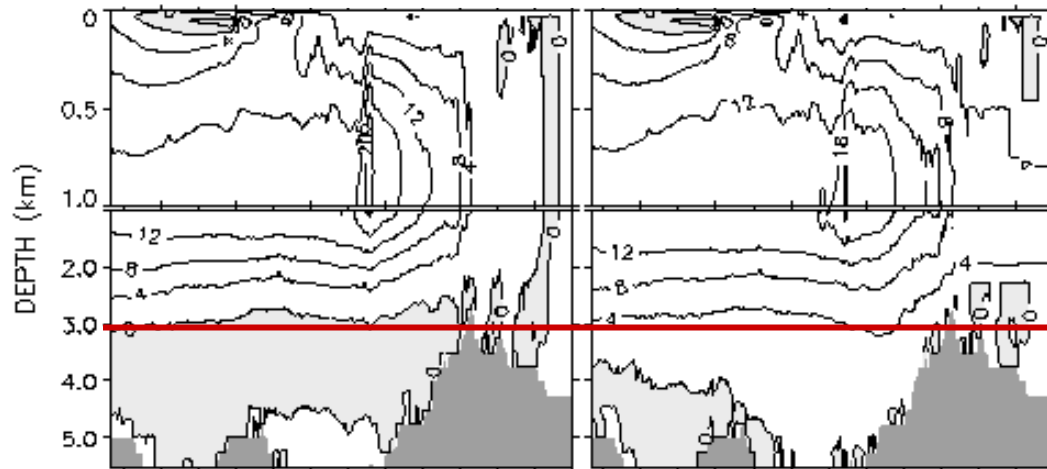

OCN*

CCSM

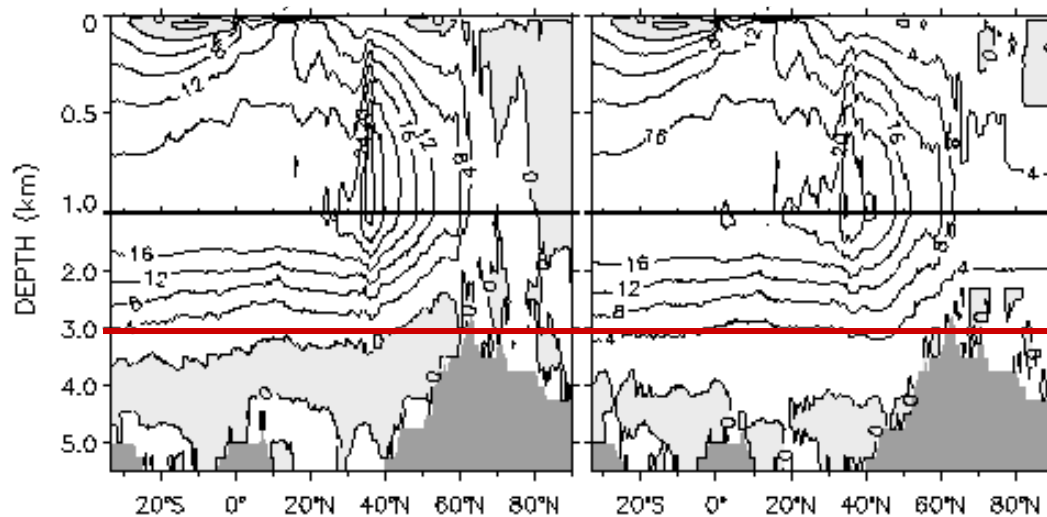

CCSM*

in Sv

* denotes with overflows

TEMPERATURE AND SALINITY DIFFERENCES FROM OBSERVATIONS AT 2649-m DEPTH

mean= 0.45°C
rms= 0.50°C

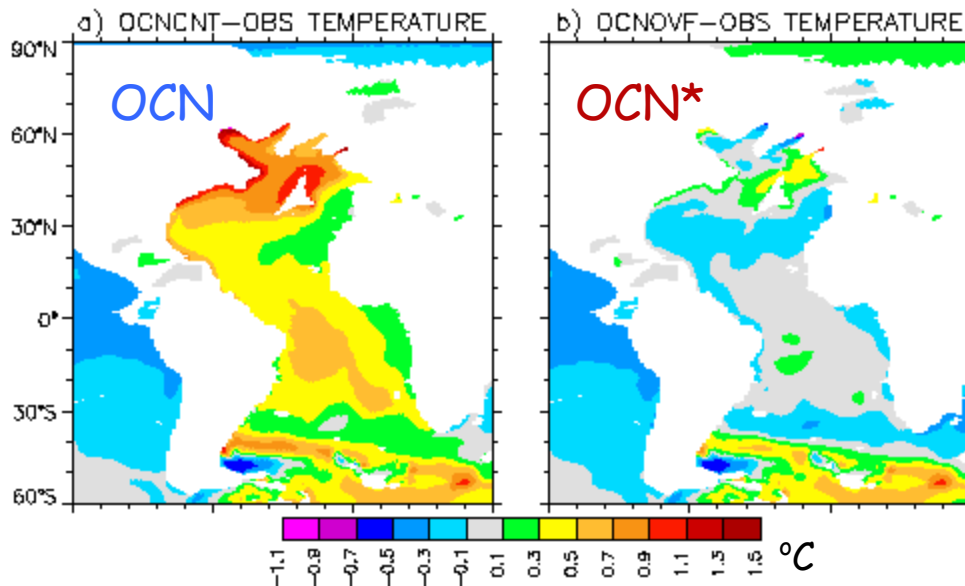

mean= -0.04°C
rms= 0.13°C

mean= 0.02 psu
rms= 0.03 psu

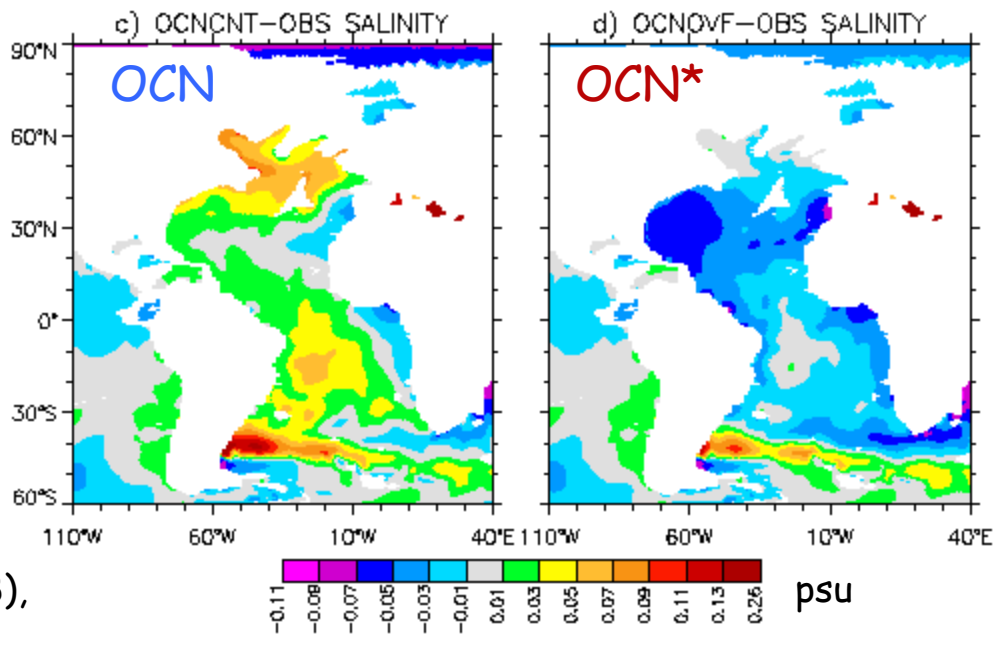

mean= -0.03 psu
rms= 0.03 psu

Obs: Levitus et al. (1998),
Steele et al. (2001)

River Runoff

CESM1 and earlier

- applied as extra precipitation at the surface
- spreading around the river mouth (300km radius)
- discharged as zero salinity
- uses global reference salinity for virtual salt flux formula

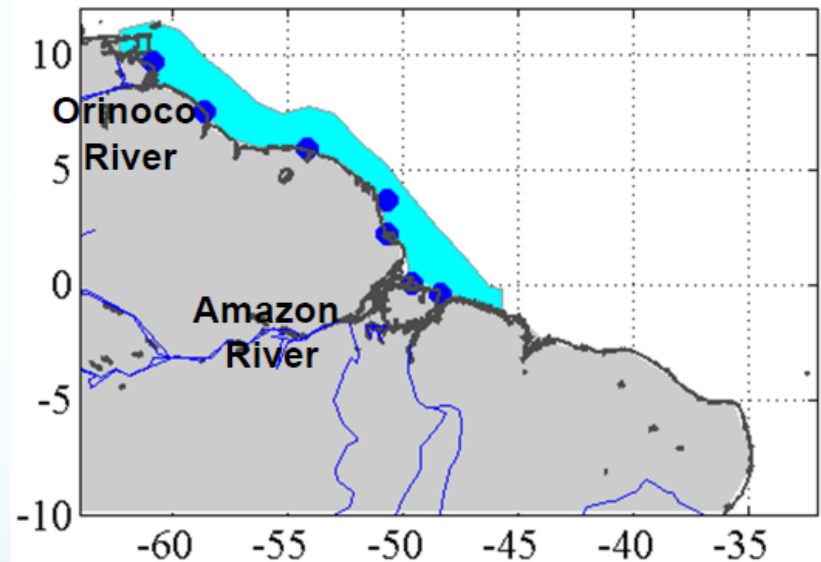
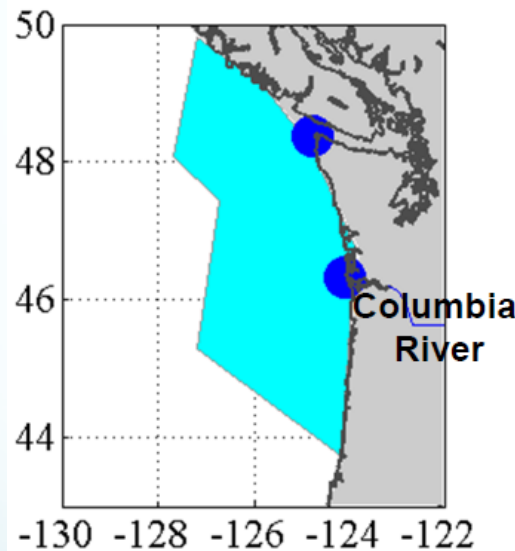

CESM2: Estuary Box Model

- maps to a point source
- Introduces estuary mixing
- local salinity used in virtual salt flux formula

River Runoff / Salinity

Model minus Obs

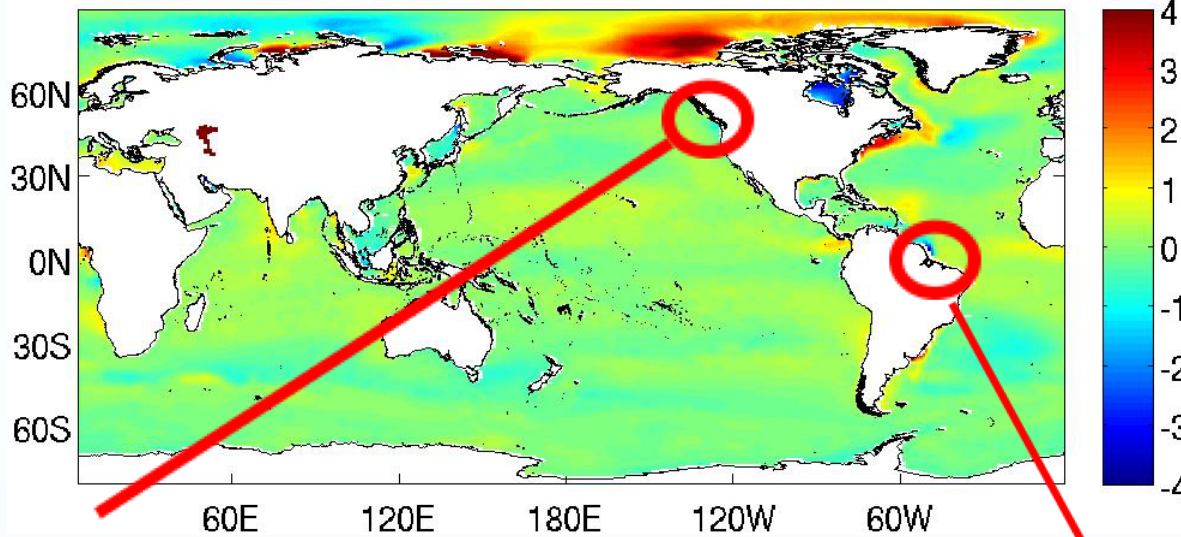

(d) B300CS - WOA13 (ppt)

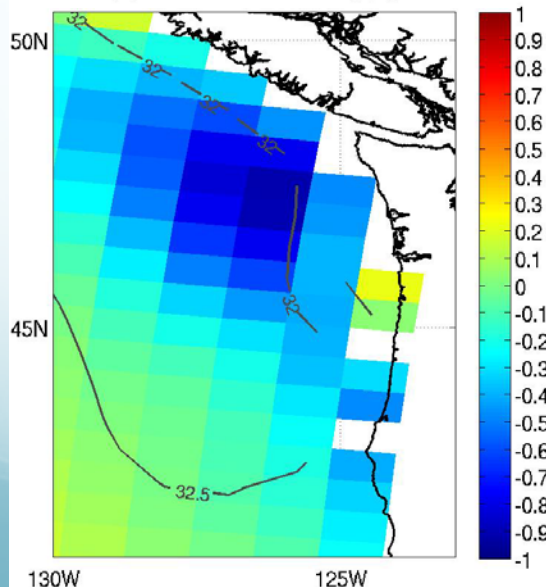

(c) B300CS - WOA13 (ppt)

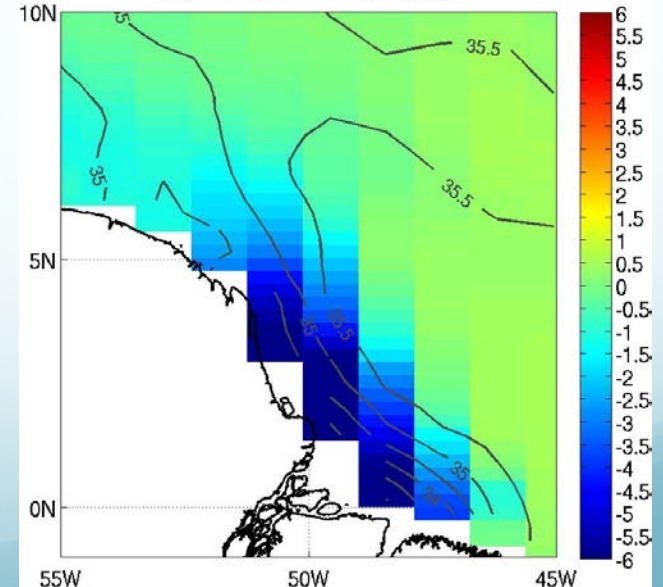

(Courtesy Qiang Sun)

River Runoff / Salinity

Control case minus case with EBM

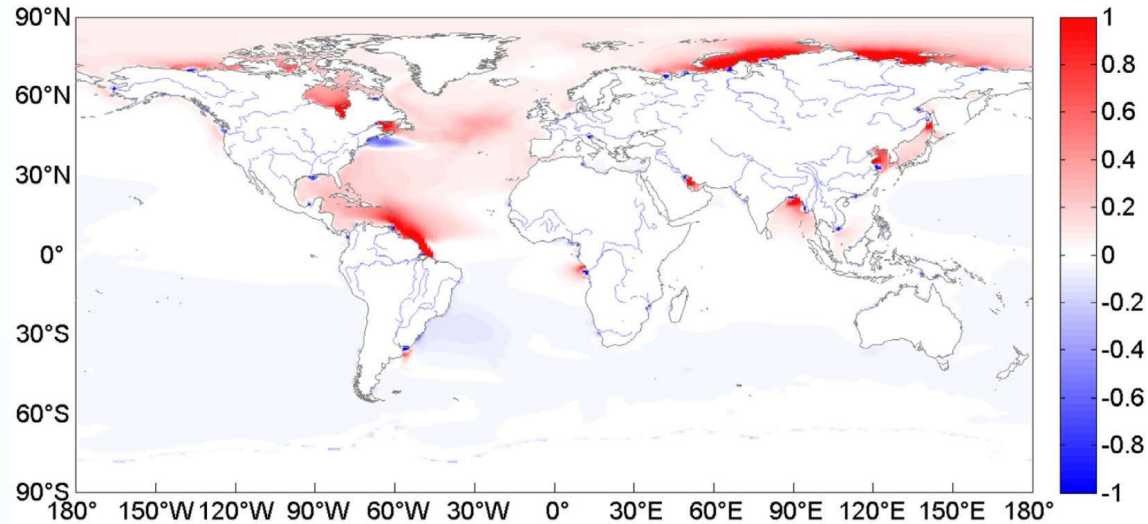

- Improves coastal salinity
- Improves stratification on the shelf – previously too much freshwater at surface

(Sun et al., *Ocean Modelling*, 2017)

CESM2 Physics Improvements

- **Estuary Box Model (EBM):** a new parameterization for mixing effects in estuaries to improve the representation of runoff reducing significant salinity and other tracers biases in river mouth regions
- **Enhanced mesoscale eddy diffusivities at depth** - aimed at improving ocean heat and carbon uptake, trying to reduce mixed layer depth biases, as well as improving the general temperature, salinity, and BGC tracer biases
- **Langmuir mixing parameterization & NOAA WaveWatch III model:** improve surface mixing
- **Prognostic chlorophyll** for short-wave absorption
- **Salinity-dependent freezing point** – used to create sea ice when temperature reached -1.8°C (coordinated with CICE)

CESM2 Numerical Improvements

- **Barotropic solver:** new iterative solver for the barotropic mode to reduce communication costs, particularly advantageous for high-resolution simulations on large processor counts
- **Robert time filter** - enables sub-daily (1 to 2 hours) coupling of the ocean model much more efficiently than the default time stepping scheme, letting us resolve the diurnal cycle explicitly leading to enhanced near-inertial mixing
- **CVmix:** the K-Profile vertical mixing Parameterization (KPP) is incorporated via the Community ocean Vertical Mixing (CVMix) framework (all vertical mixing into common module)
- **Caspian Sea:** no longer included in the ocean model as a marginal sea, part of the land model
- **MARBL:** ocean biogeochemistry has been modularized under the Marine Biogeochemistry Library (MARBL) to enable portability to alternative physical frameworks.

Into the Future

- CESM3: MOM6 (GFDL model)
- No new developments to POP

Helpful Guides

<http://www.cesm.ucar.edu/models/cesm2/ocean/CESM>

Webpage for POP

- CESM2.0 POP2 User Guide
- MARBL Documentation
- Ocean Ecosystem Model User Guide
- POP Reference Manual
- Port Validation
- Post-processing Utilities
- CESM1 User Guides and FAQ

Barotropic and Baroclinic Flow

$$U = \langle U \rangle + U'$$

- $\langle U \rangle$: Implicit, linearized free-surface formulation obtained by combining the vertically integrated momentum and continuity equations
- U' : use a leapfrog time stepping to solve

$$\frac{\chi^{t+1} - \chi^{t-1}}{2\Delta t} = D^{t-1} + ADV^t + SRC^{t,t-1}$$



Central Advection Discretization

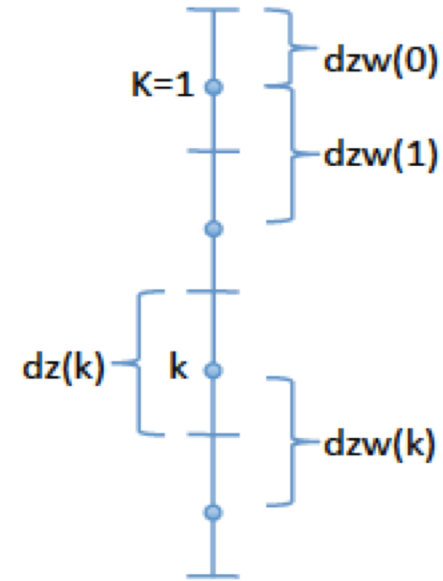
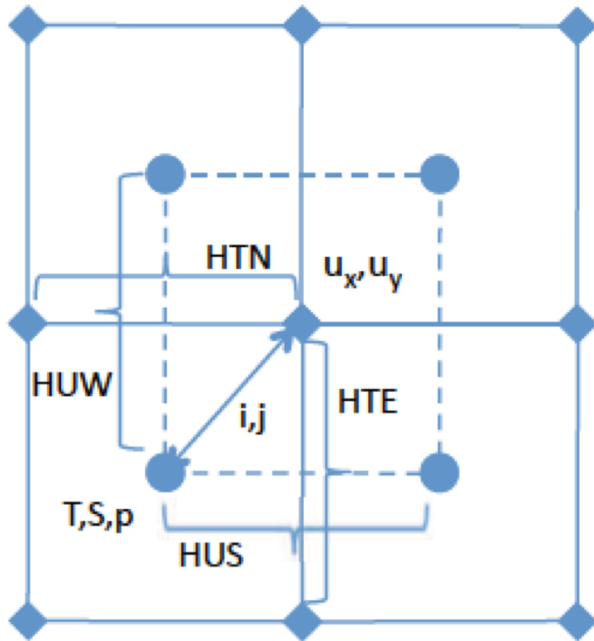

$$ADV_{i,j,k} = - (u_E T^*_E - u_W T^*_W) / DXT - (v_N T^*_N - v_S T^*_S) / DYT - (w_k T^*_T - w_{k+1} T^*_B) / dz$$

$$u_E(i) = (u_{i,j} DYU_{i,j} + u_{i,j-1} DYU_{i,j-1}) / (2DX T_{i,j})$$

$$u_W(i) = u_E(i - 1)$$

$$v_N(j) = (v_{i,j} DXU_{i,j} + v_{i-1,j} DXU_{i-1,j}) / (2DY T_{i,j})$$

$$v_S(j) = (v_{i,j-1} DXU_{i,j-1} + v_{i-1,j-1} DXU_{i-1,j-1}) / (2DY T_{i,j})$$

$$T^*_E = 1/2 * (T_{i+1,j} + T_{i,j})$$